

## Unpacking

Before using the device, check the device model and ensure that the shipped box includes the following items:

### MD06 Accessories :

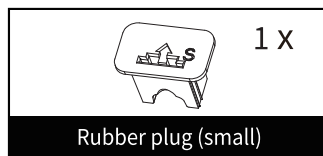
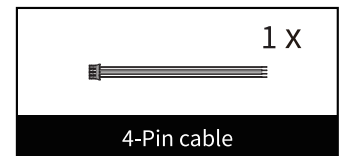
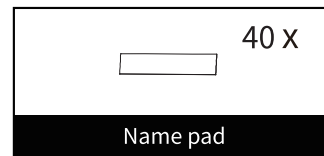
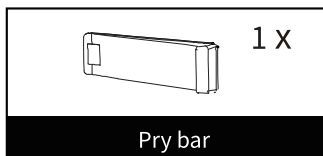
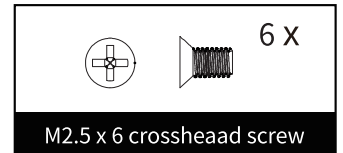
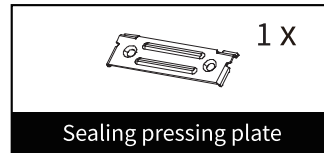
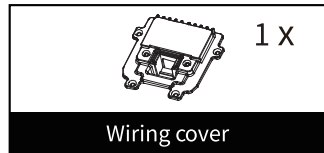
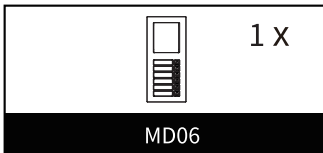

### MD12 Accessories :

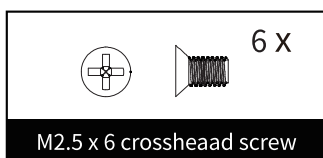
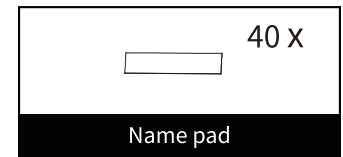
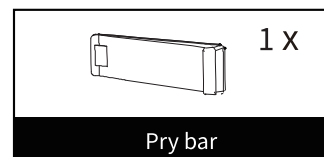
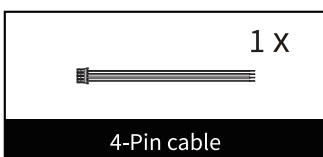
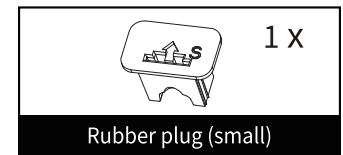
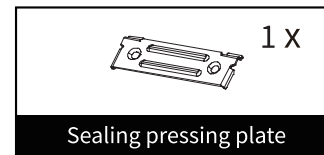
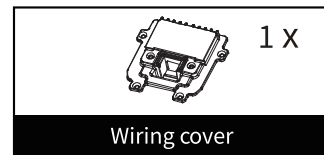
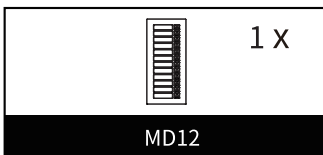

### R20K/R20B Accessories :

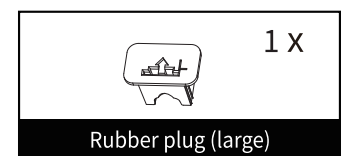
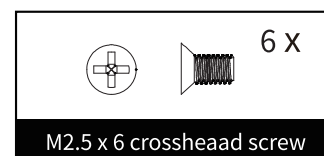
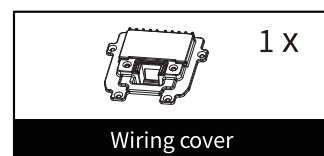
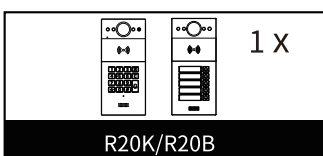

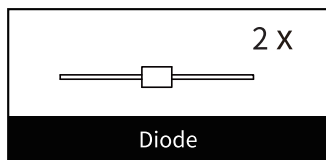
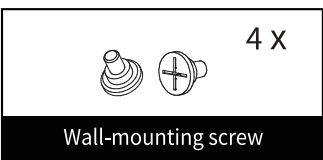
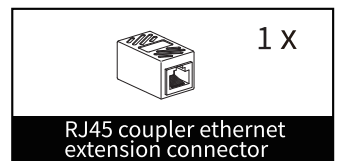
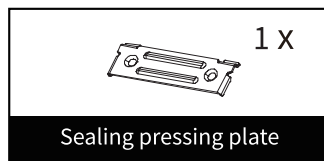
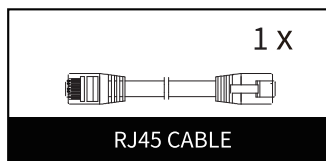
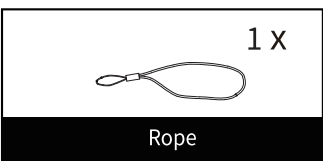
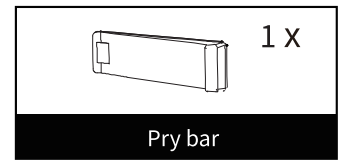
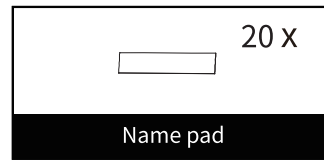
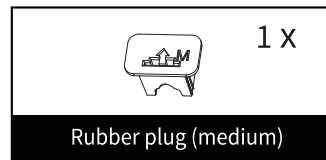
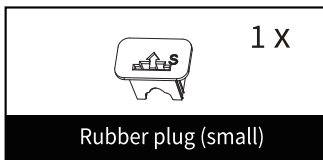

## Dual-unit Device Accessories :

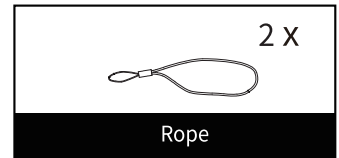
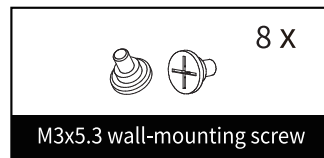
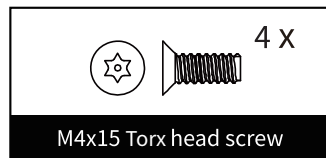
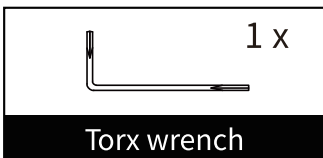
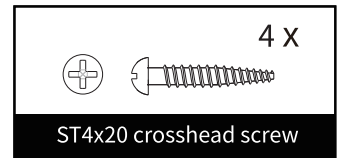
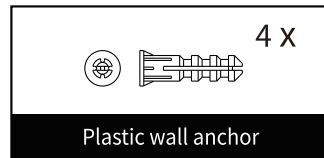
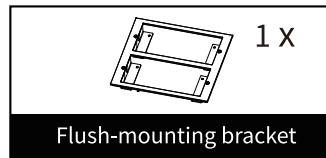
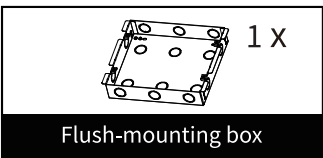

## Triple-unit device Accessories :

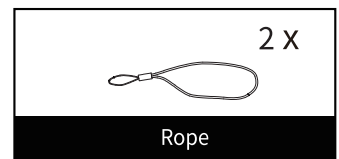
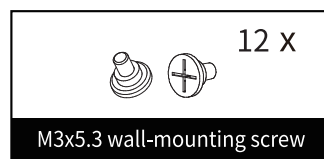
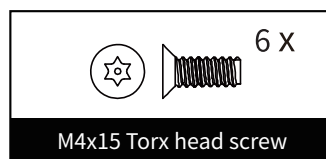
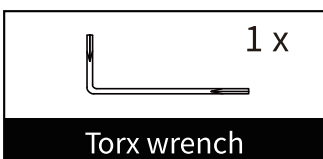
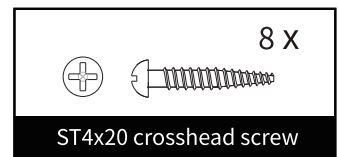
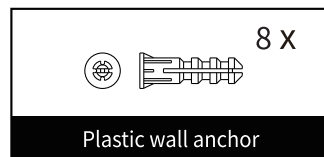
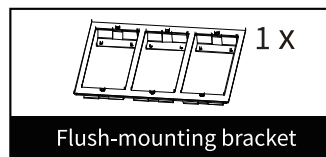
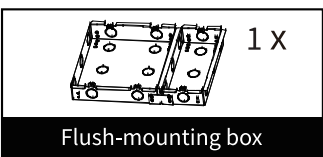

## Product Overview

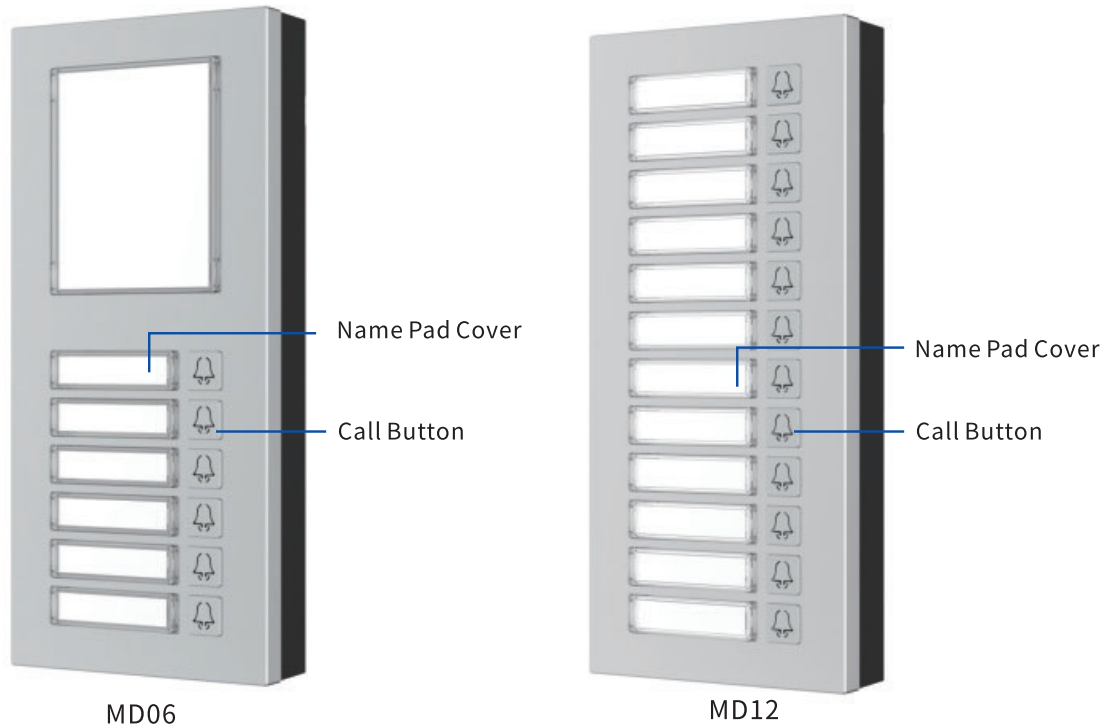

## Before You Start

### Tools needed

(not included in shipped box)

- Cat Ethernet Cable
- Crosshead Screwdriver
- Electric Drill

### Voltage and Current Specifications

- It is suggested that use 12-24VDC 0.1A power adapter to power on device.

### AWG Sizes and Properties Table

Please follow the properly wire data to install device:

Power Supply	12-24VDC 0.1A
AWG	26
Resistance (ohm/km)	128
Cross-sectional Area (mm <sup>2</sup> )	0.14
Wire Length (m)	\

## Requirements

1. Place the device away from sunlight and light sources to prevent potential damage.
2. Do not place the device in the high-temperature, and humid environments or in surroundings impacted by magnetic field.
3. Install the device on the flat surface securely to avoid personal injuries and property loss caused by device's falling.
4. Do not use or place the device near heating objects.
5. If installing the device indoors, please keep device at least 2 meters away from light, and at least 3 meters away from window and door.

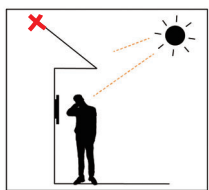

Backlight

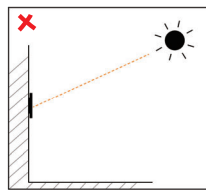

Direct sunlight

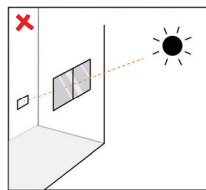

Direct sun through window

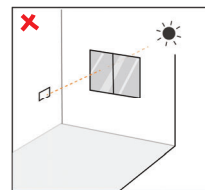

Indirect sunlight through window

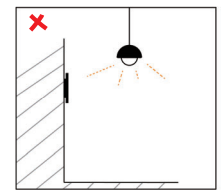

Close to light

### Warning!

1. To ensure safety, avoid touching power core, power adapter, and device with wet hands, bending or pulling the power core, damaging any components, and use only qualified power adapter and power cord.
2. Be careful that standing up on the area under the device in case of personal injuries cause by hitting the device.

### Caution

1. Do not knock device with hard objects.
2. Do not press down hard on the device screen.
3. Do not expose device to chemical products, such as alcohol, acid liquid, disinfectants, and so on.
4. To prevent the device installation from becoming loose, ensure accurate diameters and depths of screw holes. If the screw holes are too large, use glue to secure the screws.
5. Use wet cloth clean device surface softly, and then wipe the surface with dry cloth for cleaning the device.
6. If there is abnormal situation of the device, including uncommon sound and smell, please power off the device and contact Akuvox Technical Team immediately.

## Wiring Interface

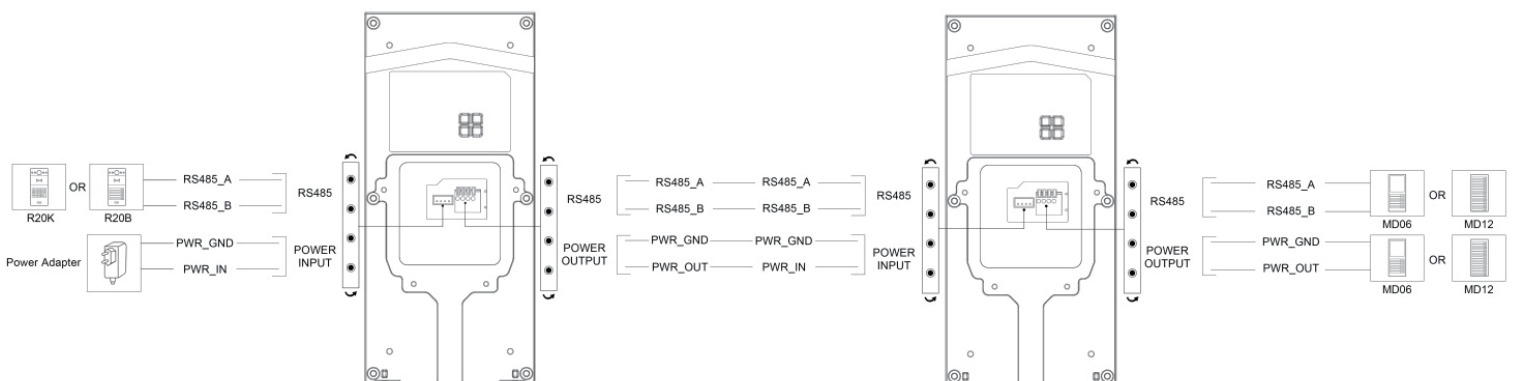

## Installation For Triple-unit Device

### Step1: Flush-mounting Box Installation

#### 1.1 Normal Installation

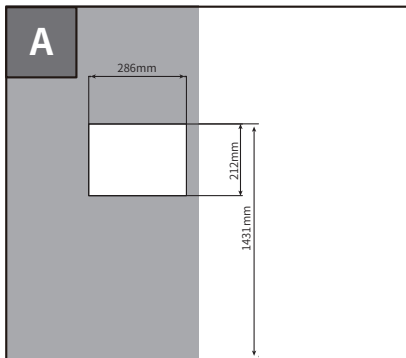

Cut out a square hole on the wall with the dimension 212\*286\*42mm (height\*width\*depth).

Note: Make sure that the cables within the hole or reserve a cable tube.

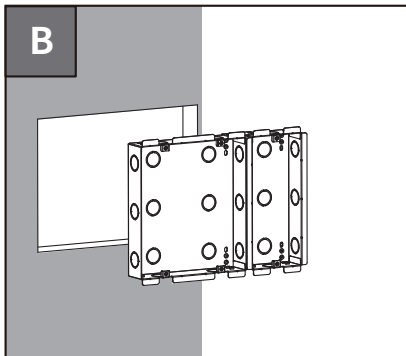

- Break out the round wiring holes of box.
- Insert **flush-mounting box** into the square hole and mark eight screw holes positions.

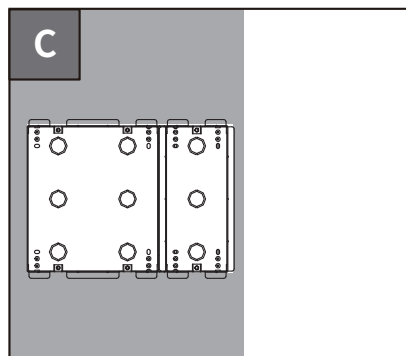

Remove the box and use a 6mm electric drill to make holes on the marked position.

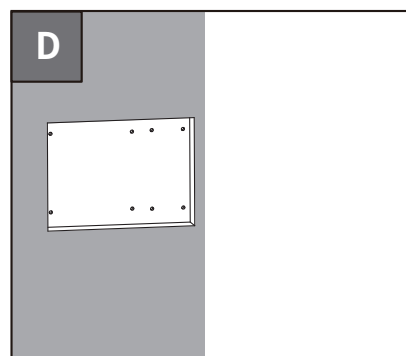

Insert eight **plastic wall anchors** into holes.

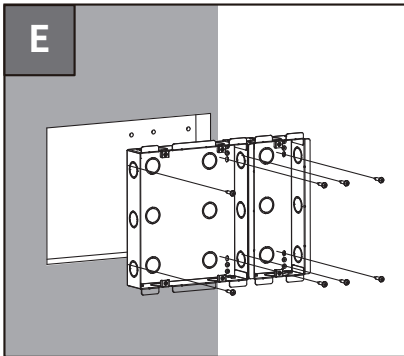

- Lead wires go through the cable holes.
- Press the **flush-mounting box** into the square hole, ensuring that the edges closely against the wall.
- Use eight **ST4x20 crosshead screws** to fix **flush-mounting box**.

Note: • The flush-mounting box is not positioned higher than wall, which can be lower 0-3mm.  
• The box tilt angle does exceed than 2°.

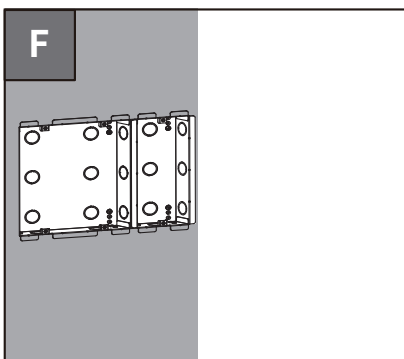

Remove the box and use a 6mm electric drill to make holes on the marked position.

## 1.2 Simple Installation (with lower resistance of vandalism)

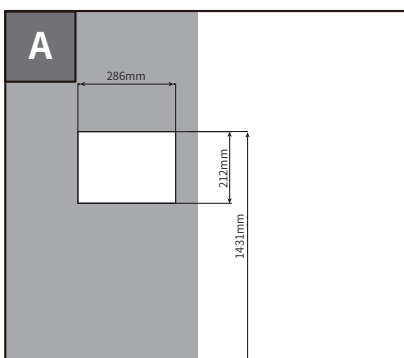

Cut out a square hole on the wall with the dimension 212\*286\*42mm (height\*width\*depth).

Note: Make sure that the cables within the hole or reserve a cable tube.

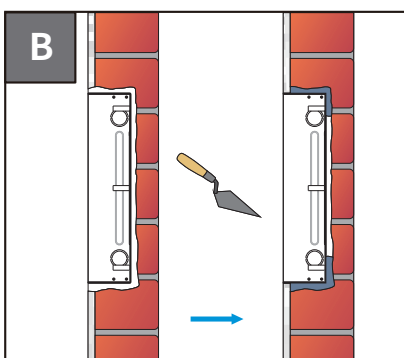

- Fill the gap between the wall and the **flush-mounting box** with cement or non-corrosive adhesive.
- Brush the outer surface of the gap with the same decorative materials as the surrounding walls.
- Wait for the cement to dry before proceeding to the next step.

Note: To prevent water from entering the back cover of the door phone, it is recommended to fill the gaps around with waterproof material.

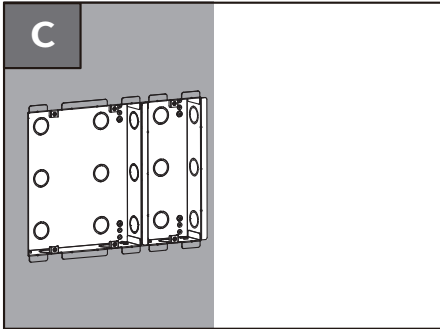

The flush-mounting box installation is done.

## Step2: Main Unit Installation

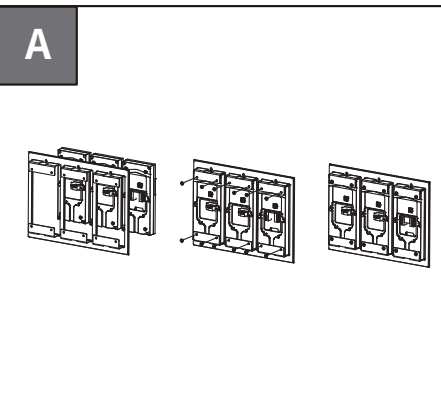

- a. Combine R20K/B, MD06, and MD12 with the **flush-mounting bracket** according to the direction indicated in the drawing.
- b. Use twelve **M3x6.8 wall-mounting screws** to fasten devices.

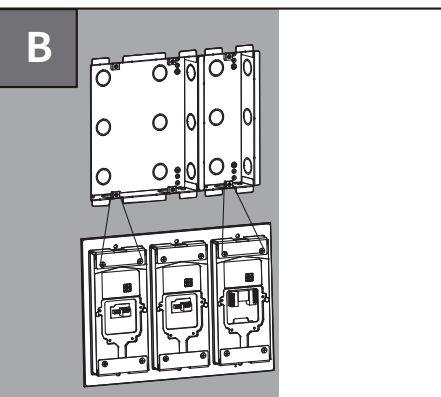

- a. For easier installation, hang the device on the box/bracket using the **rope**.
- b. Press **sealing ring** into the corresponding groove.

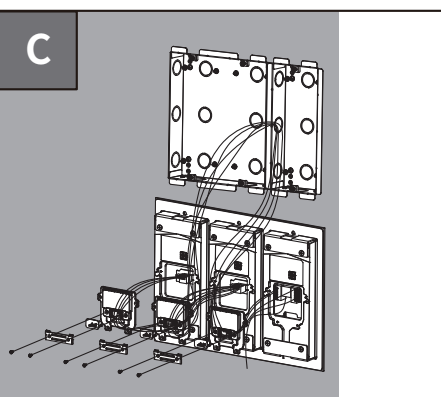

- a. Insert **4-Pin cable** to terminal of MD06 and MD12.
- b. Make cables go through the **wiring cover**, connecting to the corresponding interfaces as needed (for details, refer to "Wiring Interface").
- c. Fasten **rubber plug (M)** to R20K/B device and **rubber plug (S)** to MD06 and MD12 device for securing cables.
- d. Fasten **sealing pressing plate** with two **M2.5x6 crosshead screws**.

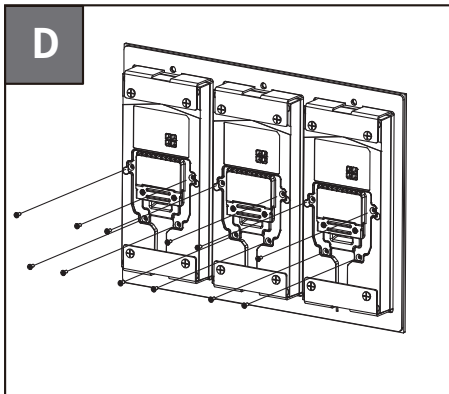

Fasten **wiring cover** with **M2.5x6 crosshead screws**.

## Step3: Device Mounting

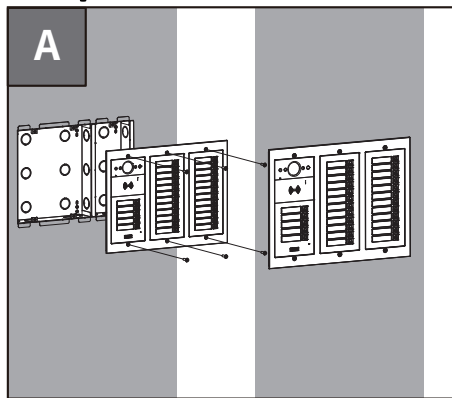

Use the **M4 Torx wrench** to tighten the device with four **M4x15 Torx head screws**. Installation is completed.

## For Dual-unit Device

### Step1: Flush-mounting Box Installation

#### 1.1 Normal Installation

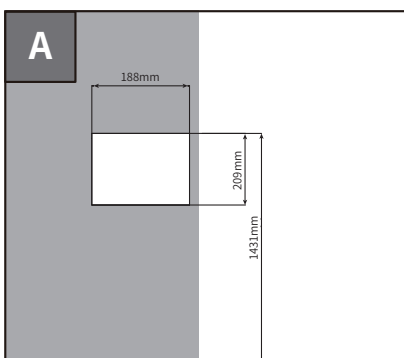

Cut out a square hole on the wall with the dimension 209\*188\*40mm (height\*width\*depth).

Note: Make sure that the cables within the hole or reserve a cable tube.

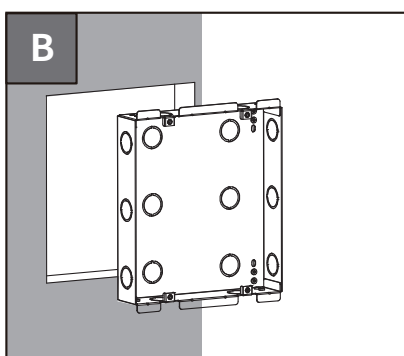

- Break out the round wiring holes of box.
- Insert **flush-mounting box** into the square hole and mark four screw holes positions.



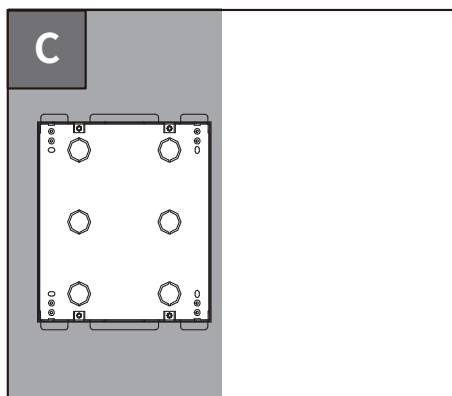

Remove the box and use a 6mm electric drill to make holes on the marked position.

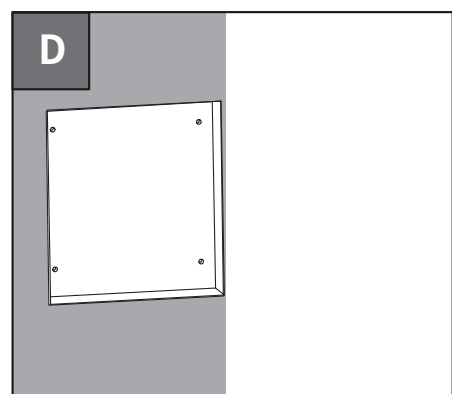

Insert four plastic wall anchors into holes.

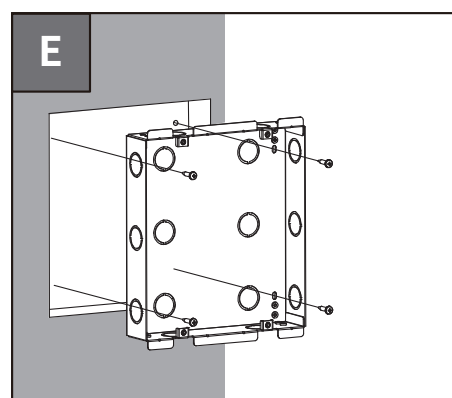

- Lead wires go through the cable holes.
- Press the **flush-mounting box** into the square hole, ensuring that the edges closely against the wall.
- Use four ST4x20 crosshead screws to fix **flush-mounting box**.

Note: • The flush-mounting box is not positioned higher than wall, which can be lower 0-3mm.  
• The box tilt angle does exceed than 2°.

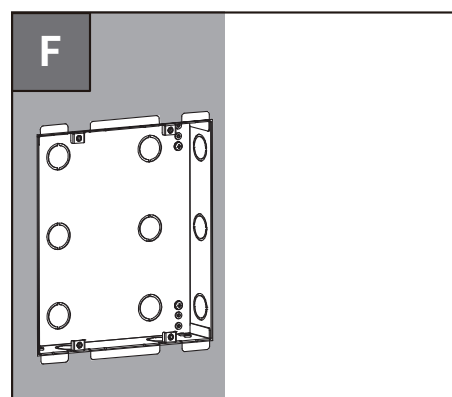

The flush-mounting box installation is done.

## 1.2 Simple Installation (with lower resistance of vandalism)

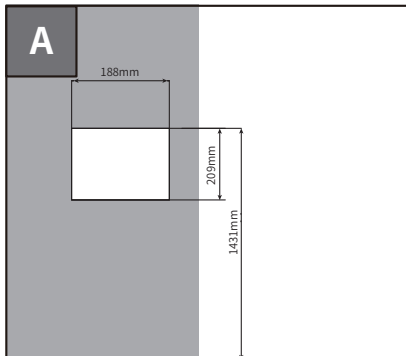

Cut out a square hole on the wall with the dimension 209\*188\*40mm (height\*width\*depth).

Note: Make sure that the cables within the hole or reserve a cable tube.

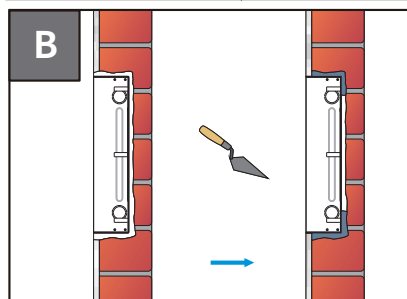

- Fill the gap between the wall and the **flush-mounting box** with cement or non-corrosive adhesive.
- Brush the outer surface of the gap with the same decorative materials as the surrounding walls.
- Wait for the cement to dry before proceeding to the next step.

Note: To prevent water from entering the back cover of the door phone, it is recommended to fill the gaps around with waterproof material.

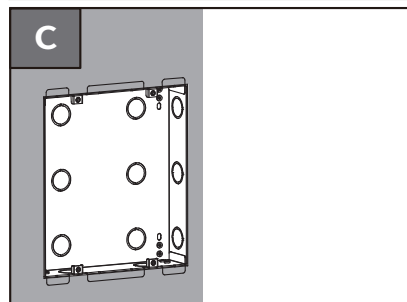

The flush-mounting box installation is done.

## Step2: Main Unit Installation

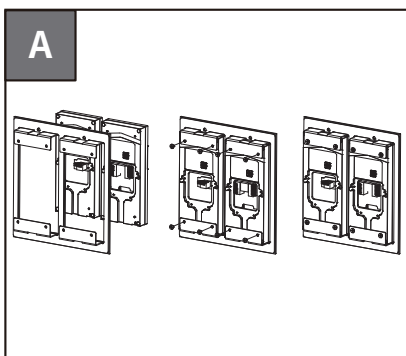

- Combine R20K/R20B and MD06/MD12 with the **flush-mounting bracket** according to the direction indicated in the drawing.
- Use eight **M3x6.8 wall-mounting screws** to fasten devices.

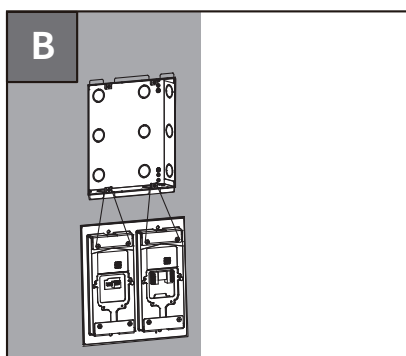

- For easier installation, hang the device on the box/bracket using the **rope**.
- Press **sealing ring** into the corresponding groove.

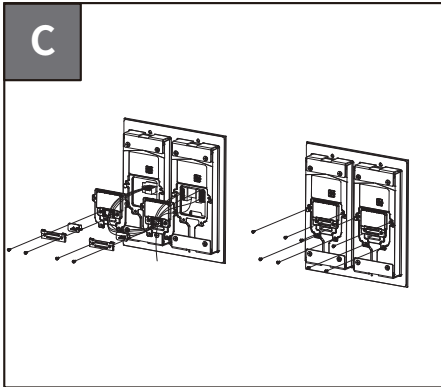

- Insert **4-Pin cable** to terminal of MD06/12.
- Make cables go through the **wiring cover**, connecting to the corresponding interfaces as needed (for details, refer to "Wiring Interface").
- Fasten **rubber plug (M)** to R20K/B device and **rubber plug (S)** to MD06/12 device for securing cables.
- Fasten **sealing pressing plate** and **wiring cover** with **M2.5x6 crosshead screws**.

## Step3: Device Mounting

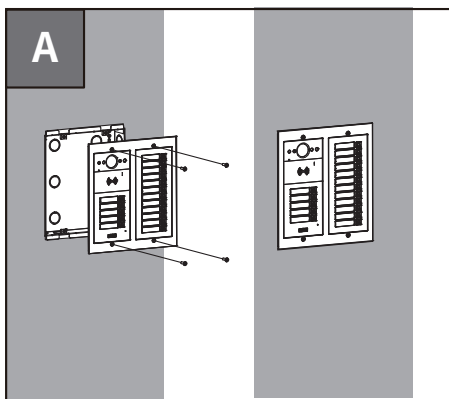

Use the **Torx wrench** to tighten the device with four **M4x15 Torx head screws**. Installation is completed.

## Application Network Topology

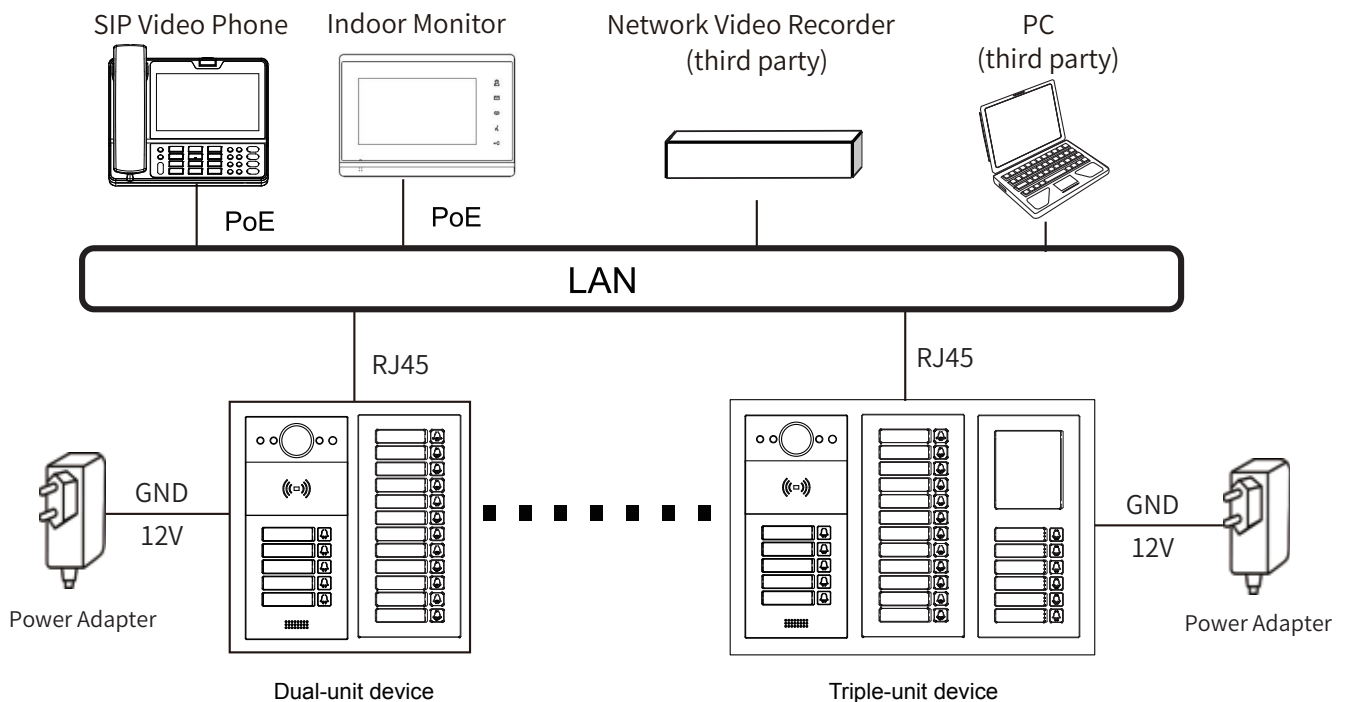

## Device Test

Please verify the device status after installation:

1. **Network:** Check the device's IP address and network status. Network is working properly if the IP address is obtained. If no IP address is obtained, R20X will announce "IP 0.0.0.0".

- For R20K: Press **\*3258\*** to obtain IP address.
- For R20B: Long press the first **Call Button** for 5 seconds.

2. **Intercom:** Press Call Button to make a call. The call configuration is correct if the call is successful.

3. **Access Control:** Use pre-configured RF card to unlock door.

## Warranty

1. Akuvox warranty does not cover intentional mechanical damage or destruction caused by improper installation.
2. Do not attempt to modify, alternate, maintain, or repair device by yourself. Akuvox warranty does not apply to damages caused by anyone who is not representative of Akuvox or an Akuvox authorized service provider. Please contact Akuvox Technical Team if the device need to be repaired.

## Get Help

For help or more assistance, contact us at:

 <https://ticket.akuvox.com/>

 [support@akuvox.com](mailto:support@akuvox.com)

Scan the QR code to get more videos, guides, and additional product information.



## Notice Information

Information contained in this document is believed to be accurate and reliable at the time of printing. This document is subject to change without notice, any update to this document can be viewed on Akuvox' s website:

<http://www.akuvox.com> © Copyright 2023 Akuvox Ltd. All rights reserved.

